

LE 10 REGOLE DELLA NETIQUETTE

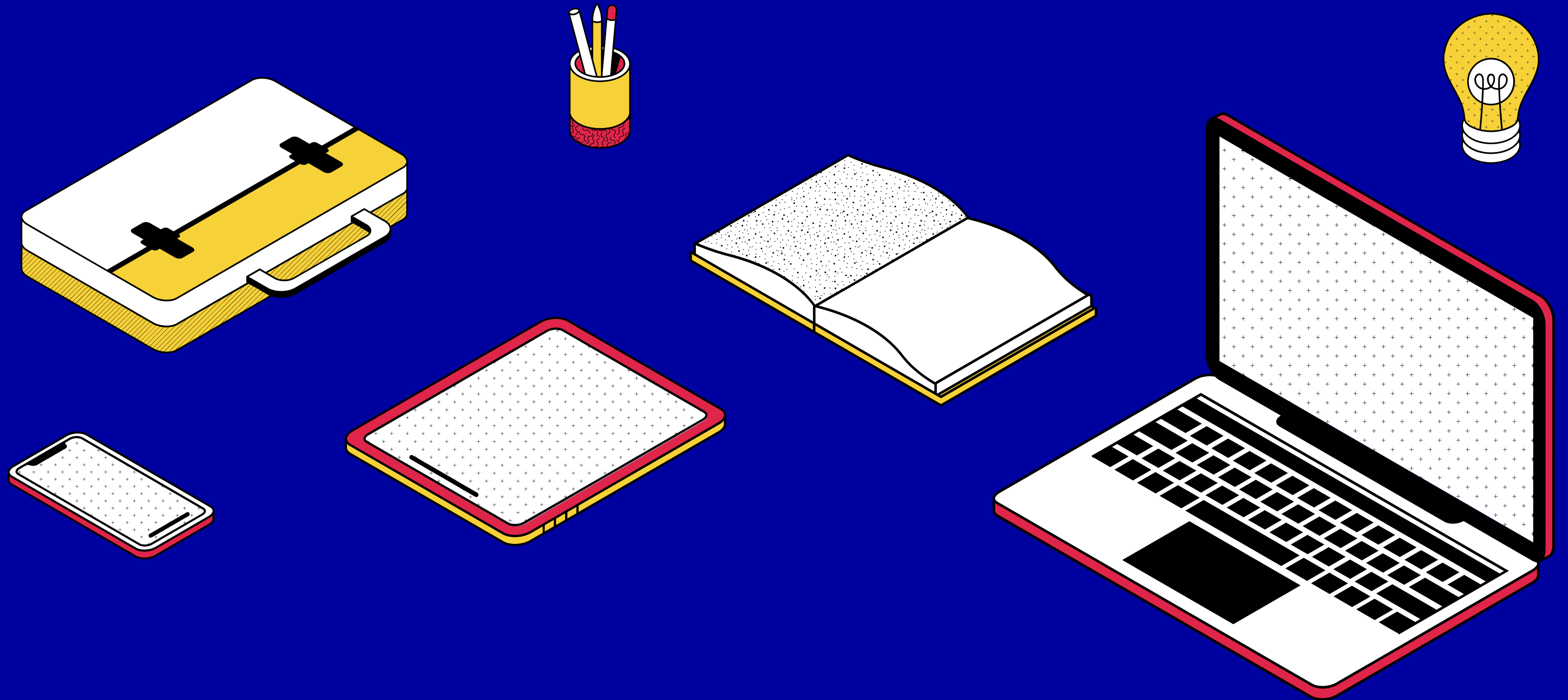

SII RISPETTOSO NEI CONFRONTI DEGLI ALTRI

*Tratta gli altri con
gentilezza e rispetto,
evitando di offendere o
discriminare qualcuno.*

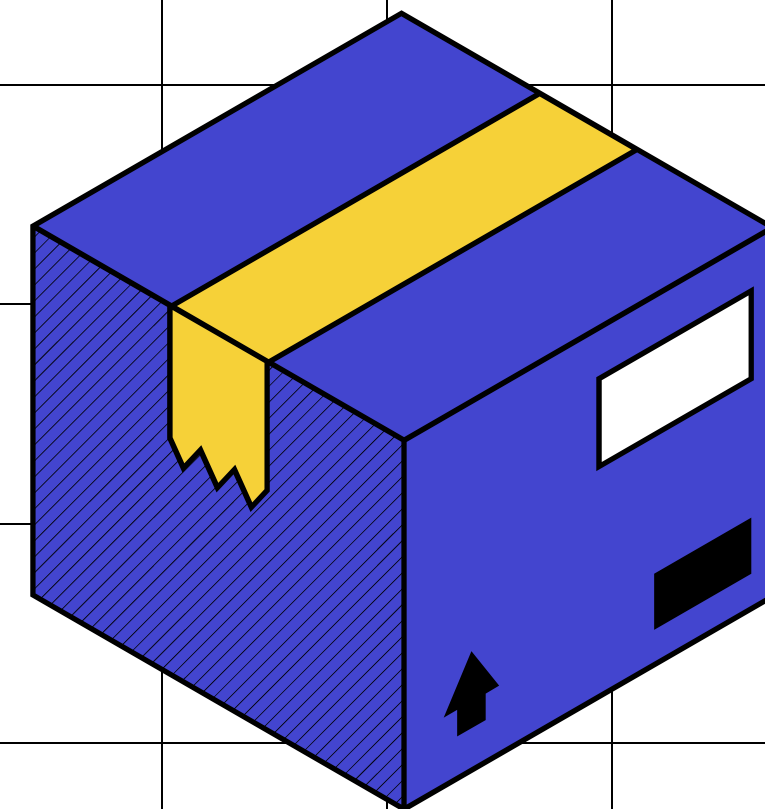
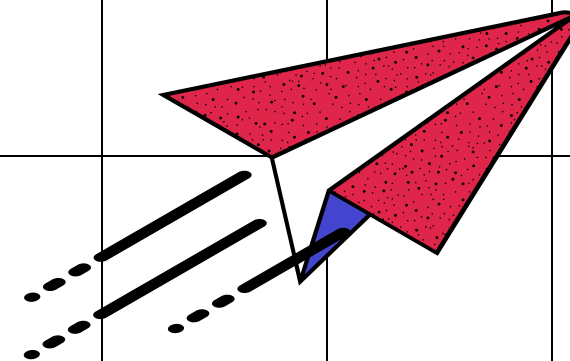
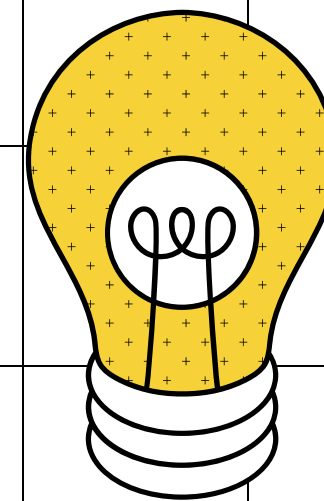

NON INVIARE SPAM O MESSAGGI INDESIDERATI

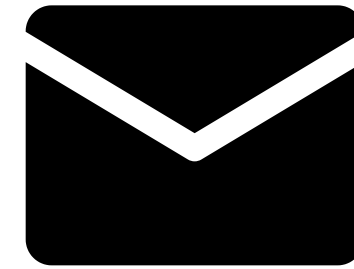

- Non inviare messaggi di posta elettronica non richiesti o pubblicità non sollecitata ad un gran numero di persone.

- Rispetta l'utente con cui parli online, non mandare messaggi che potrebbero dargli fastidio.

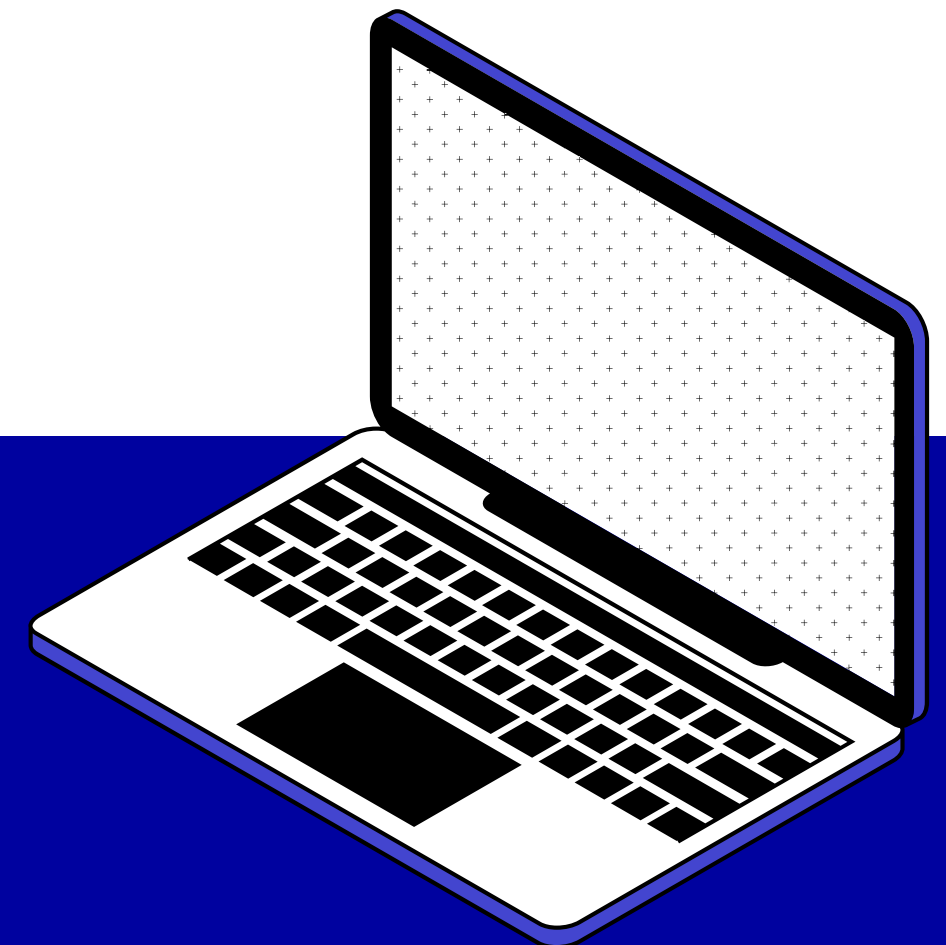
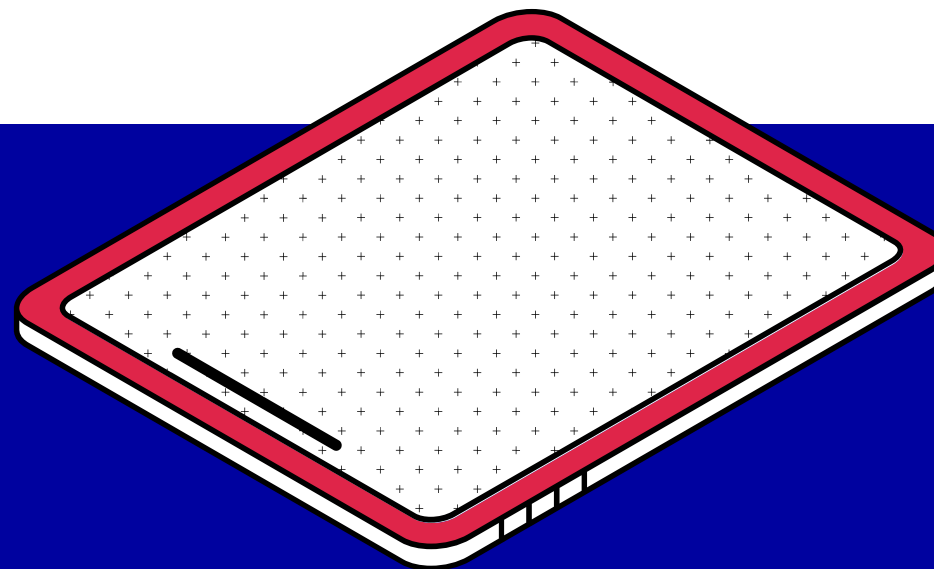
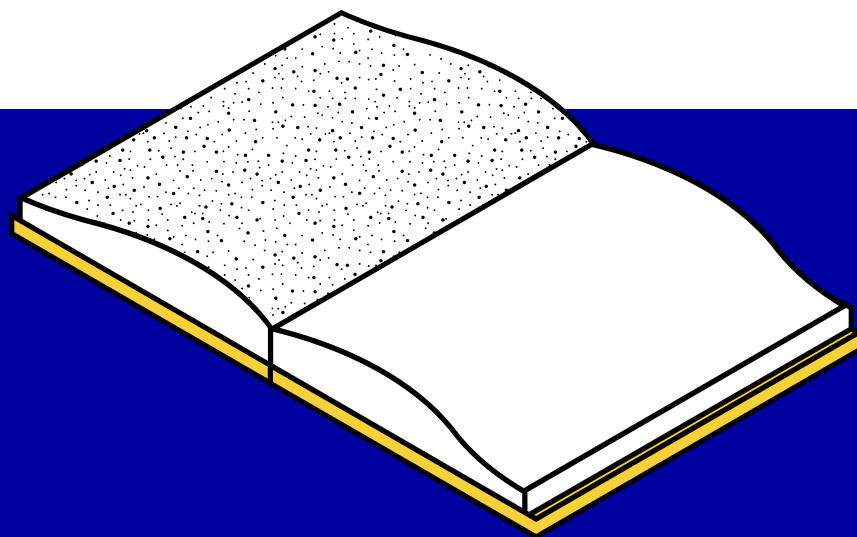

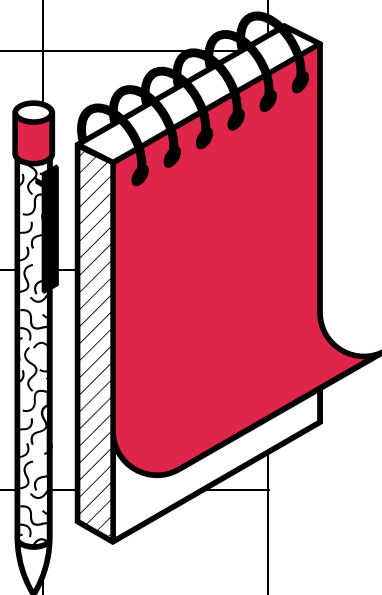
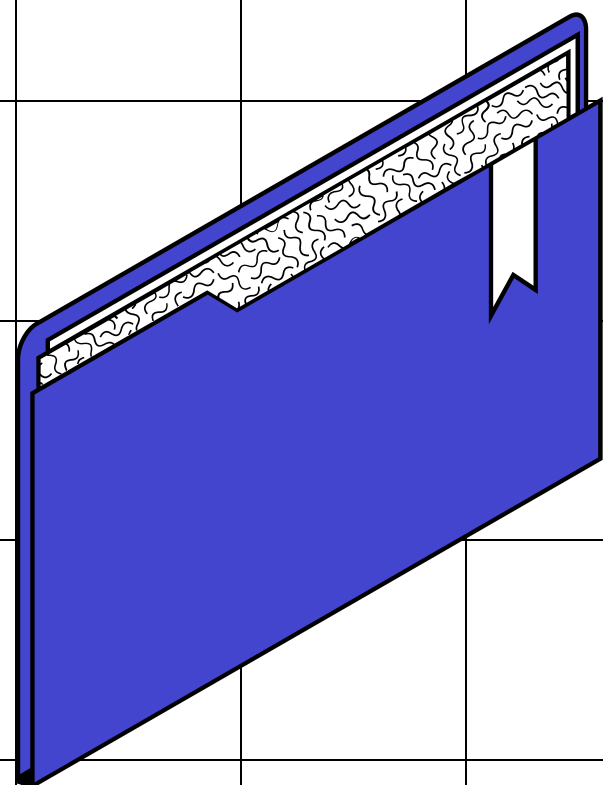
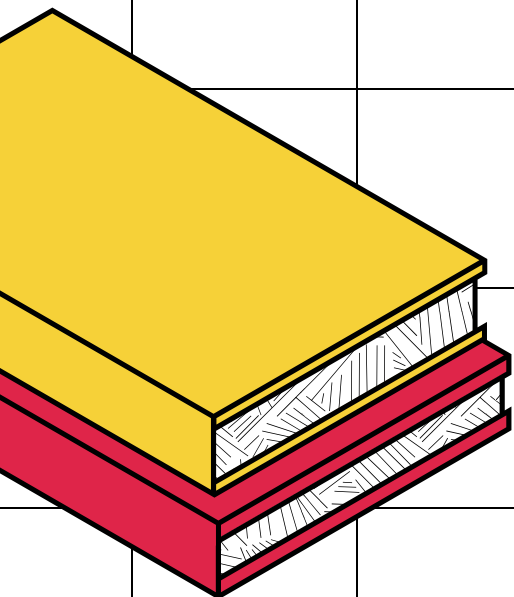

USA UN LINGUAGGIO APPROPRIATO

Evita di utilizzare un linguaggio volgare o offensivo e rispetta le norme della comunicazione formale e informale.



NON DIFFONDERE INFORMAZIONI PERSONALI DEGLI ALTRI



Non condividere
informazioni
personali degli
altri senza il loro
consenso.

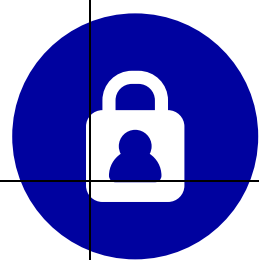

NON UTILIZZARE IL COMPUTER PER COMMETTERE REATI

Non utilizzare il
computer per
commettere reati,
come la truffa o la
frode.

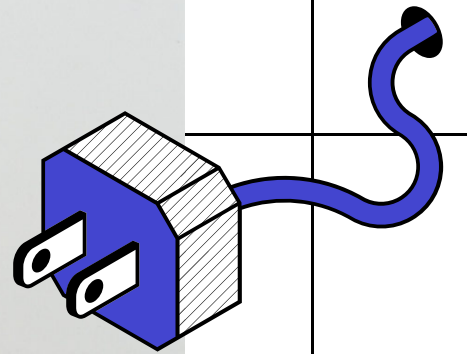
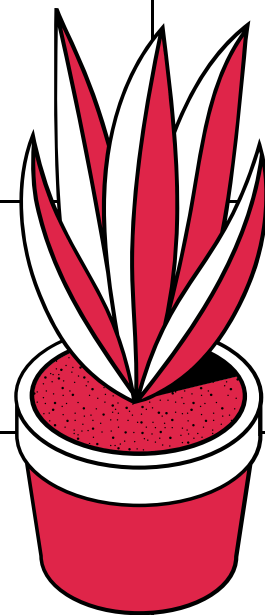
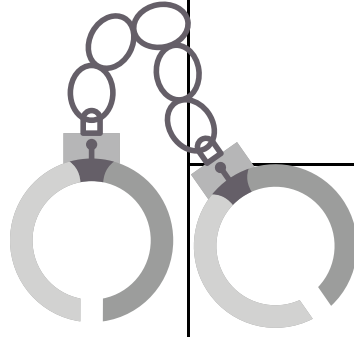
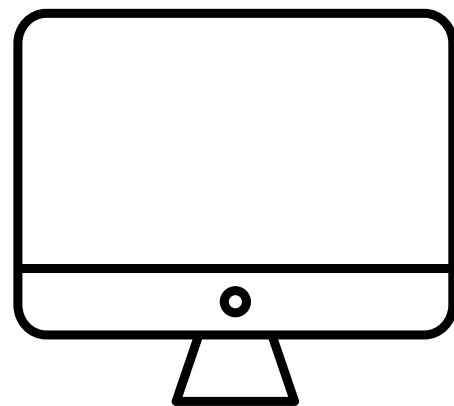

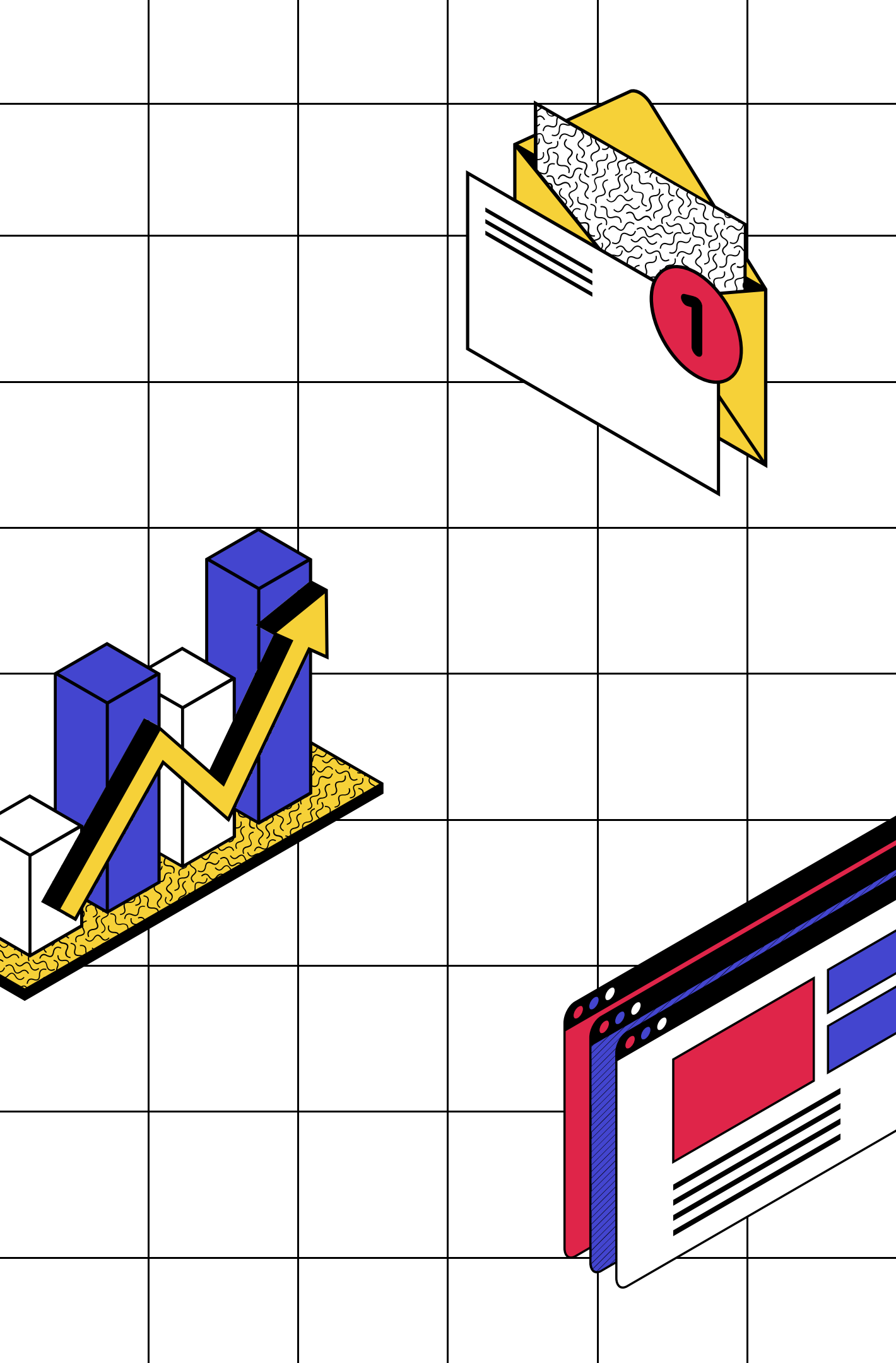

RISPETTA IL DIRITTO D'AUTORE

Il diritto d'autore è un insieme di leggi che proteggono le opere creative, come libri, musica, film e software, dalla riproduzione e utilizzo non autorizzato, garantendo al creatore il controllo e il riconoscimento delle sue opere.

Rispetta il diritto d'autore evitando di utilizzare o diffondere contenuti protetti dalle leggi sul diritto d'autore senza autorizzazione.



NON FALSIFICARE IL TUO INDIRIZZO DI POSTA ELETTRONICA O L'IDENTITÀ DEGLI ALTRI

Non utilizzare indirizzi di posta elettronica o identità false per ingannare gli altri.

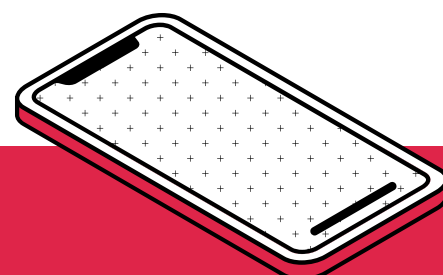
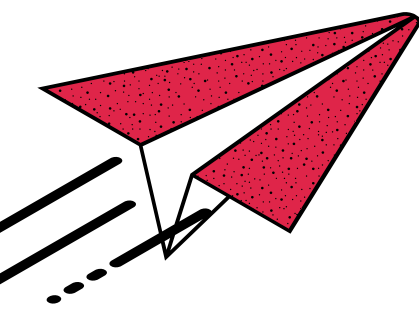

**NON UTILIZZARE IL
COMPUTER PER
MOLESTARE O
INTIMIDIRE GLI ALTRI**

**Non utilizzare il
computer per molestare
o intimidire gli altri.**

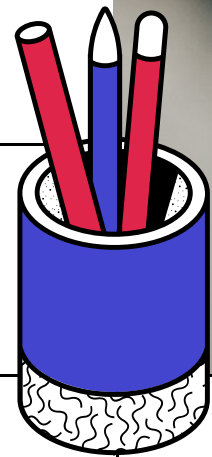

NON ACCEDERE A INFORMAZIONI O COMPUTER CHE NON TI SONO STATI AUTORIZZATI

Non accedere a
informazioni o computer
protetti da password o
sistemi di sicurezza
senza autorizzazione.

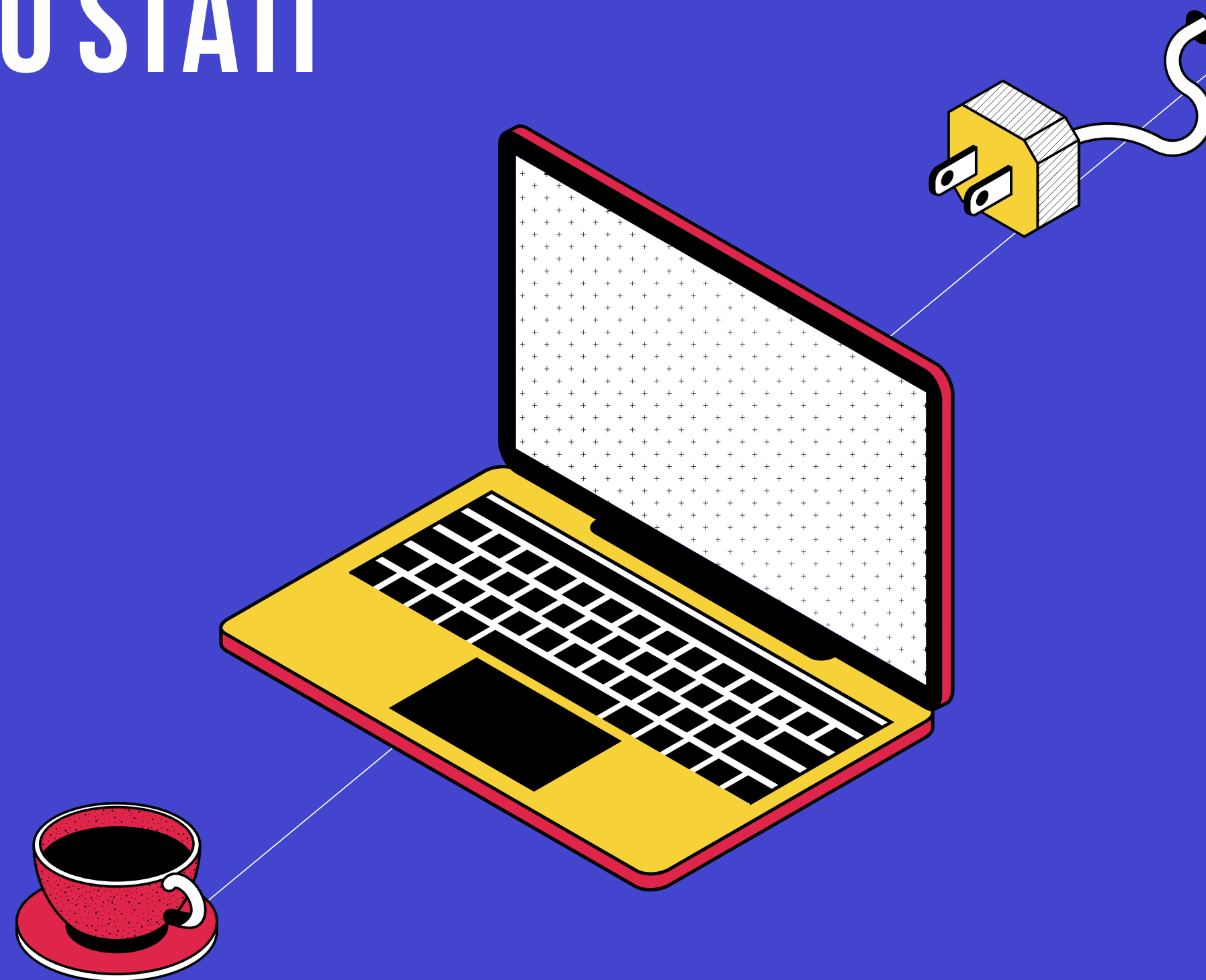

RISPETTA LA PRIVACY DEGLI ALTRI:



Rispetta la privacy degli altri evitando di accedere o diffondere informazioni personali senza il loro consenso.